

FR	GUIDE UTILISATION	BRUKSANVISNING	NO
EN	USER GUIDE	BRUKSANVISNING	SV
CS	PRŮVODCE INSTALACÍ	INSTRUKCJA INSTALACJI	PL
DA	BRUGSANVISNING	ΟΔΗΓΙΕΣ ΧΡ ΗΣΗΣ	ΕΛ
DE	GEBRAUCHSANLEITUNG		
ES	GUÍA DE UTILIZACIÓN		
FI	KÄYTTÖOHJE		
IT	MANUALE D'USO		

TABLE INDUCTION

INDUCTION HOB
INDUKČNÍ VARNÁ DESKA
INDUKTIONSPLADE
INDUKTIONSKOCHFELD
PLACA DE INDUCCIÓN
INDUKTIOTASO
PIANO A INDUZIONE
INDUKSJONSTOPP
PLATŇA INDUKTIONSHÄLL
PLŶTA INDUKCYJNA
ΕΠΑΓΩΓΙΚΕΣ ΕΣΤΙΕΣ

FR	GUIDE UTILISATION	BRUKSANVISNING	NO
EN	USER GUIDE	BRUKSANVISNING	SV
CS	PRŮVODCE INSTALACÍ	INSTRUKCJA INSTALACJI	PL
DA	BRUGSANVISNING	ΟΔΗΓΙΕΣ ΧΡ ΗΣΗΣ	ΕΛ
DE	GEBRAUCHSANLEITUNG		
ES	GUÍA DE UTILIZACIÓN		
FI	KÄYTTÖOHJE		
IT	MANUALE D'USO		

INDUCTION HOB

EN

DEAR CUSTOMER

Discovering De Dietrich products means experiencing unique emotions. The attraction is immediate from the moment you set eyes on the product.

The sheer quality of the design shines through, thanks to the timeless style and outstanding finishes which make each component an elegant and refined masterpiece in its own right, each one in perfect harmony with the others.

Next, comes the irresistible urge to touch it.

De Dietrich's design makes extensive use of robust and prestigious materials. By combining state-of-the-art technology with top quality materials,

De Dietrich

produces beautifully crafted products to help you get the most from the culinary arts, a passion shared by all lovers of cooking and fine food.

We hope that you enjoy using this new appliance.

Thank you for choosing a De Dietrich product.

www.dedietrich-electromenager.com



De Dietrich 



Important :

Before using your appliance, read this user guide carefully to familiarise yourself more quickly with its operation.

Safety and important precautions	4
Environment.....	6
Presentation.....	7
Installation.....	9
Unpacking.....	9
Building in.....	9
Connection	11
Use.....	12
Power management	13
Choice of cookware	13
Cooking zone selection	13
Switching on and off	13
Power setting.....	14
Horizone	14
Setting the timer	14
Elapsed time key	15
Locking the controls.....	15
Clean lock function	16
ICS function.....	16
Recall function	16
Switch function	16
Boil function	17
Horizone Play	17
Grill / Griddle function.....	17
Safety devices and recommendations.....	18
Care.....	19
Problems	20
Customer service	21



IMPORTANT SAFETY ADVICE AND PRECAUTIONS

IMPORTANT SAFETY INSTRUCTIONS TO BE READ CAREFULLY AND KEPT FOR FUTURE USE.

This guide can be downloaded from the brand web site.

This appliance can be used by children over 8 years old and persons with reduced physical, sensory or mental capabilities or without experience and knowledge if they have been correctly informed or trained in the use of the appliance in a safe way and understand the hazards involved.

Children must not play with the appliance.

Children must not clean and maintain the appliance without supervision.

Children under 8 years old must be kept away from the hob unless they are supervised at all times.

The appliance and its accessible parts become hot during use.

Precautions must be taken to avoid touching the heating elements.

Metal objects such as knives, forks, spoons and lids must not be placed on the cooking surface as they may heat up.

Your hob is equipped with a child safety device that locks its operation after use or during cooking (See “Child Safety use” section).

Your appliance complies with applicable European Directives and regulations.

In order to avoid interference between your cooking hob and a pacemaker, the pacemaker must be designed and programmed in compliance with the regulations that apply to it. Ask the pacemaker manufacturer or your GP.

Leaving oil or fat to heat unattended on a hob may be dangerous and lead to fire. NEVER attempt to extinguish a fire with water. Instead, switch off the appliance, then cover the flame with a lid or a fire blanket.

CAUTION: cooking must be monitored. Quick heating must be monitored at all times.

Danger of fire: do not store objects on the cooking areas.

If the surface is cracked, disconnect the appliance to avoid the risk of electric shock.

Do not use your hob until you have replaced the glass worktop.

Avoid hard shocks from cookware: although the vitroceramic glass worktop



IMPORTANT SAFETY ADVICE AND PRECAUTIONS

is very sturdy, it is not unbreakable.

Do not place any hot lids flat on your cooking hob. A suction effect may damage the vitroceramic surface. Avoid dragging cookware across the surface, which may in the long-term result in the degradation of the decorative finish of the vitroceramic top.

Never use a sheet of aluminium for cooking. Never place items wrapped in aluminium foil or packaged in aluminium dishes on your cooking hob. The aluminium will melt and permanently damage your appliance.

Do not store cleaning products or flammable products in the cabinet underneath your cooking hob.

These hobs must be connected to the power grid via an all-pole cut-off device that complies with installation regulations in effect. A disconnection device must be incorporated into the fixed wiring.

Your cooktop is designed to operate at 50Hz or 60Hz (50Hz/60Hz) without any special intervention on your part.

After use, switch off the hob by means of the control device and do not rely on the pot sensor.

If the power cable is damaged, it should be replaced by the manufacturer, its after-sales service department or a similarly qualified person to avoid danger.

Ensure that the power cables of any electrical appliances plugged in close to the hob are not in contact with the cooking zones.

Never use a steam cleaner to clean your cooking hob.

The appliance is not designed to be switched on using an external timer or a separate remote control system.

WARNING: Only use hob protectors designed by the manufacturer of the cooking appliance or listed as suitable in the user guide, or included with the appliance. Use of unsuitable protectors could cause accidents.

ENVIRONMENT

Protecting the environment



This symbol indicates that this product should not be treated as household waste.

Your appliance also contains a great amount of recyclable material. It is marked with this symbol to indicate that used appliances must be disposed of in certified collection points.

Contact your town hall or your retailer for the used appliance collection points closest to your home. This way, the appliance recycling organised by your manufacturer will be done under the best possible conditions, in compliance with European Directive on Waste Electrical and Electronic Equipment.

This appliance's packing materials are also recyclable. Help recycle it and protect the environment by dropping it off in the municipal receptacles provided for this purpose.

We thank you for your help in protecting the environment.

Advice on how to save energy

Cooking with the correctly sized lid saves energy. If you use a glass lid, you can control your cooking perfectly.

1 PRESENTATION



a



Horizone^{tech}
b

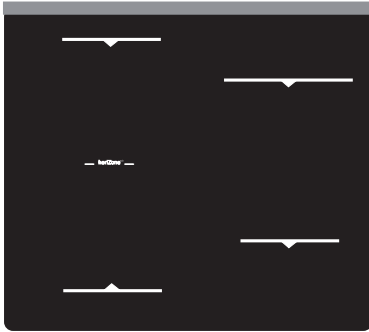

Horizone Play
c



Horizone^{tech}
d

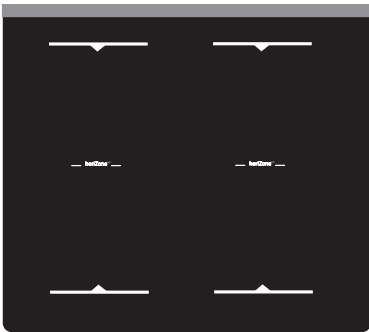

Horizone Play
e

1 PRESENTATION

🏠	◇	◇	ICS	🔄	=	<input type="text"/>		<input type="text"/>	🍷	🍷	🍷	BOOST	🍷		1	2	3	4	5
①	◇								🌙	🌞	-	+			6	7	8	9	0

a

🏠	◇	◇	ICS	🔄	=	<input type="text"/>		<input type="text"/>	🍷	🍷	🍷	BOOST	🍷		1	2	3	4	5
①	◇	◇							🌙	🌞	-	+			6	7	8	9	0

Horizon™
b

🏠	◇	◇	ICS	🔄	=	<input type="text"/>		<input type="text"/>	🍷	🍷	🍷	BOOST	🍷		1	2	3	4	5
①	◇	◇							🌙	🌞	-	+			6	7	8	9	0

Horizon Play™
c

🏠	◇	◇	ICS	🔄	=	<input type="text"/>		<input type="text"/>	🍷	🍷	🍷	BOOST	🍷		1	2	3	4	5
①	◇	◇							🌙	🌞	-	+			6	7	8	9	0

Horizon™
d

🏠	◇	◇	ICS	🔄	=	<input type="text"/>		<input type="text"/>	🍷	🍷	🍷	BOOST	🍷		1	2	3	4	5
①	◇	◇							🌙	🌞	-	+			6	7	8	9	0

Horizon Play™
e

2 INSTALLATION

2.1 UNPACKING

For future use, remove all protective elements. Check and respect the appliance's characteristics that appear on the nameplate. Note in the boxes below the service and standard references shown on this plate.

Service :

Type :

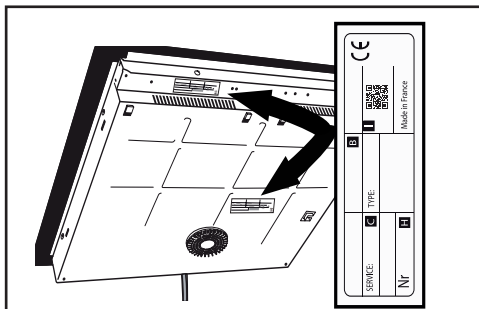

2.2 ENCLOSURE

Check that the air intake and outlet are free of obstruction. Comply with the information concerning the fitting dimensions (in millimetres) of the work top destined to receive the hob. Check that air circulates correctly between the front and the back of your hob.

Fitting into the worktop A

Fitting flush with the worktop B

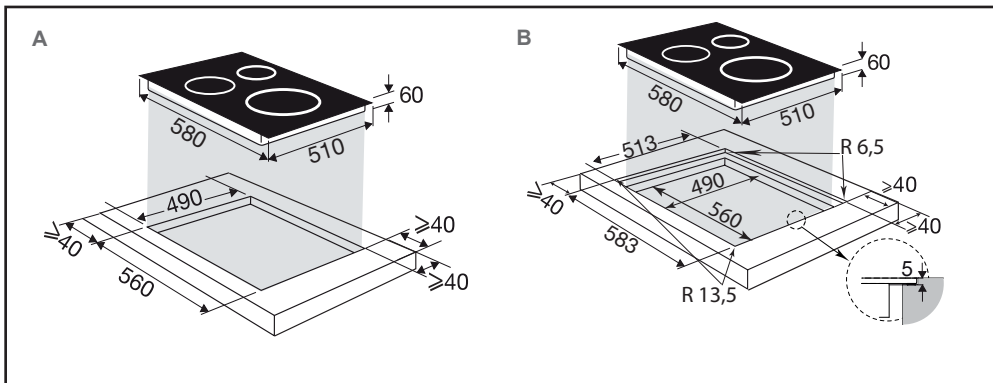
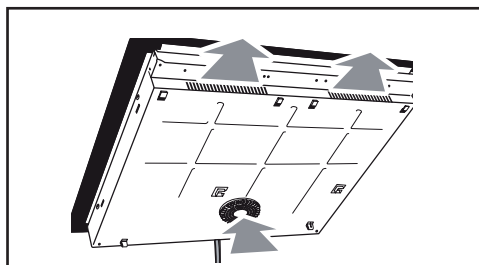

2 INSTALLATION

If you are installing the hob above a drawer,



or above a built-in oven, comply with the dimensions provided on the illustrations to ensure a sufficient air outlet at the front.

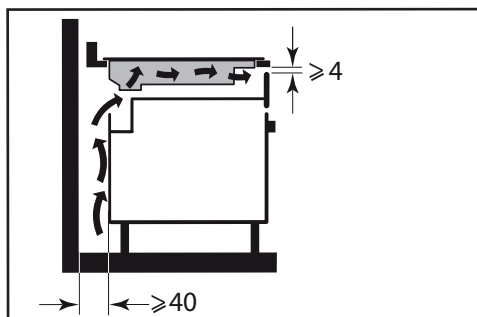

Carefully glue the sealing joint to the entire surround of the glass hob

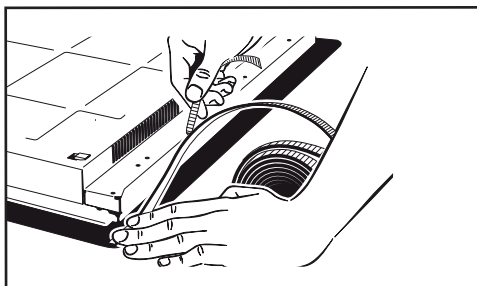

insert the table into the cabinet

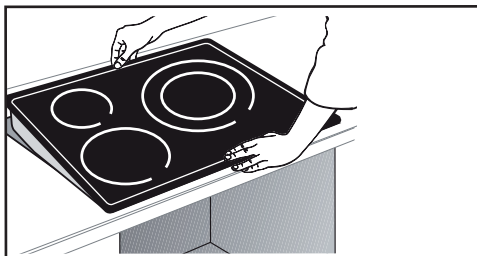

2 INSTALLATION



Important

If your hob is located above your oven, the hob's thermal safety devices can impede the simultaneous use of the hob and the oven's pyrolysis programme, display code "F7" in the control zones. In such circumstances we recommend that you increase the hob's ventilation by creating an opening in the side of the cabinet (8 x 5 cm).

2.3 Electric connections

These hobs must be connected to the power grid via an all-pole cut-off device that complies with installation regulations in effect. A disconnection device must be incorporated into the fixed wiring.

Identify the type of cable of your hob according to the number of wires and colours.

When switching your hob on or after a lengthy power cut, a code is shown on the control pad (this display is reserved for your after-sales service, where applicable. The user of the hob does not need to take notice of it).

This information disappears after around 30 seconds.

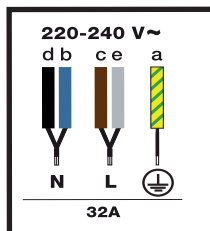

3 USE

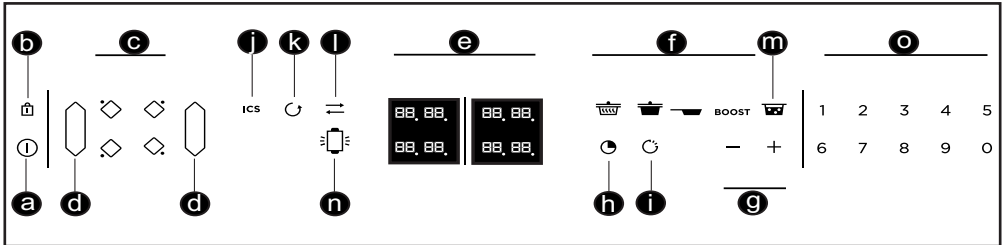

Control panel glossary

- a** = Switch on and off
- b** = Locking / Clean Lock
- c** = Choice of cooking zone
- d** = Horizone
- e** = Display
- f** = Pre-selection
- g** = Power / time setting
- h** = Timer
- i** = Elapsed time function
- j** = ICS function
- k** = Recall function
- l** = Switch function
- m** = Boil function
- n** = Grill function
- o** = Choice of numeric panel
power / time

3 USE

3.1 POWER MANAGEMENT

The total power consumed by your hob must be consistent with the power of your electrical installation.

Potencia placa kW	Fusibles / Disyuntor (A)
7,4	32

 Ensure that the power selected is compatible with the hob's fuses.

Depending on the power level selected, the division of power between the cooking zones will be affected.

3.2 CHOICE OF COOKWARE

Most cookware is compatible with induction. Only glass, terracotta, aluminium without a special base, copper and some non-magnetic stainless steels do not work with induction cooking.

 We suggest that you choose cookware with a thick, flat bottom. The heat will be distributed better and cooking will be more uniform. Never leave an empty pan to heat unattended.

 Avoid putting cookware on the control panel.

3.3 COOKING ZONE SELECTION

There are several cooking zones available. Select one which is suitable, based on the size of the pan. If the base of the cookware is too small, the power indicator will start to flash and the cooking zone will not work, even if the cookware's material is recommended for induction. Take care not to use pans which are smaller in diameter than the cooking zone (see table)

Diameter of cooking zone (cm)	Max. power of cooking zon (Watts)	Diameter of bot-tom of cookware (cm)
16	2400	10 - 18
18	2800	11 - 22
23	3700	12 - 24
28	5000	15 - 32
Horizone	5000	18 - Ovale - fishmonger
1/2 zone	2800	11 - 22

 When several cooking zones are used at the same time, the hob manages the power distribution, so as not to exceed its total power.

When you use maximum power (Boost) on several cooking zones at the same time, position pans to achieve the best positioning and avoid arrangements .

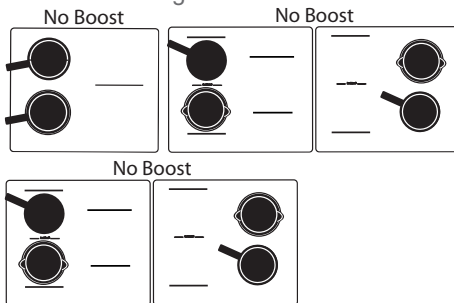

3.4 SWITCHING ON/OFF

Press the On/Off key  . «0» flashes in each zone for 8 seconds.

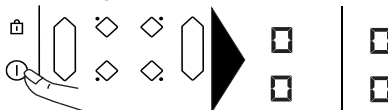

If no pan is detected, select a zoner.

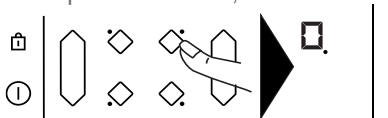

If a pan is detected, the «0» flashes with a dot. You can then set the power level. The cooking area heats up automatically.

Switching off a zone on the hob

Press and hold the key for zone  , a long beep sounds and the display goes off or an «H» appears (residual heat).

Press the On/Off key to switch the hob off completely.

3 USE

3.5 SETTING THE POWER

Press the + or - **g** key or use numeric keypad **o** to adjust your power level between 1 and 19. In this case you can enter the number corresponding to the desired power setting directly. Pressing the «0» key switches the hob off.

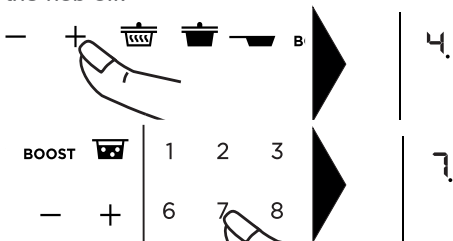

When switching on, you can go directly to maximum power (apart from boost) by pressing the «-» key for the zone.

Power presets

There are four **f** keys available that provide direct access to pre-set power levels:

= power 2 - Keep warm

= power 10 - Simmer

= power 19 - Sear

BOOST = maximum power



These power values can be modified, except for BOOST.

Proceed as follows:

The hob must be switched off.

- Press and hold or or to select it.

- Set the new power setting by pressing on the + or - button.

- A beep will confirm your action after a few moments.

Note: Power levels must be between

1 and 3 for

4 and 11 for

12 and 19 for

3.6 HORIZONE

— Horizone^{tech} —

The free zone is selected with touchkey **d**

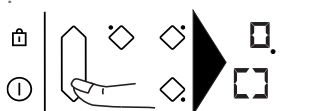

The power and timer are adjusted as for a normal cooking zone.

To switch the zone off, press and hold key **d**, a long beep sounds and the displays go off or the «H» symbol appears.

Pressing the touchkey in front of or behind the zone deactivates the function and transfers the settings to the selected zone.

3.7 SETTING THE TIMER

Each cooking zone has a dedicated timer. It can be used as soon as the cooking zone is turned on.

To switch it on or change it, press the timer touchkey **h**



and then the + or - **g**

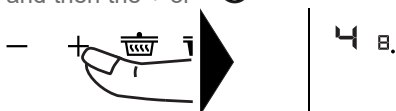

or use the numeric keypad **o**

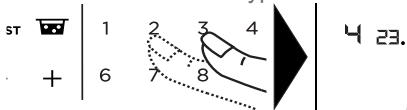

In this case you can enter the figures for the desired time directly, one after the other.

Pressing the «0» key switches off the timer.

To make setting a very long time easier, you can go straight to 99 minutes by pressing the - touchkey.

At the end of cooking, the display indicates 0 and a warning beep sounds. To cancel this information, press any button for the particular

3 USE

cooking zone being used. Otherwise, they will switch off after a few seconds.

To stop the timer during cooking, press the + and - keys at the same time or return to 0 using the - key or enter «0» on the numeric keypad.

Independent timer

This function allows you to time an event, without cooking.

- Select a cooking zone you are not using.



- Press the **h**.

- Set the time with touchpad **g**. A “t” flashes in the display.

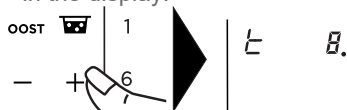

- At the end of your adjustment “t” becomes fixed and the count begins.

Note:

You can stop a count in progress by keeping your finger on the touchpad of the selection on the display.

3.8 Touche ELAPSED TIME

This function displays the time since the power setting was last changed for a selected cooking zone. To use this function, press the **i**. The elapsed time flashes in the selected zone's timer display



If you want cooking to end within a specific time, press the **i** key and then, within 5 seconds, press + on the timer to increase the desired cooking time. The elapsed time is displayed fixed for 3 seconds and then the remaining time is displayed. A beep sounds to confirm your choice.

This function is available with or without the timer function.

Note: if the timer is showing a time, it is not possible to change it within 5 seconds of pressing **i**. After 5 seconds, the cooking time can be changed.

3.9 LOCKING THE CONTROLS

Child safety lock

Your hob has a child safety device which locks the controls when the hob is not in use or during cooking (to maintain the current settings). For safety reasons, only the stop key and the zone selection keys are still active and allow the hob or a cooking zone to be switched off.

Locking

Press **b** key (cadenas), until the «bloc» locking symbol appears in one of the displays and a beep confirms the operation.



Table locked in operation

The display of cooking zones in operation alternately indicates power and the locking symbol.

When you press the power or timer keys for the zones which are «on»:

«bloc» appears for 2 seconds and then switches off.

Unlocking

Press key **b** until the «bloc» locking symbol disappears from the display and a beep confirms the operation.

CLEAN LOCK function

This function locks the hob off while it is being cleaned.

To activate Clean lock:

Give a short press on key **b** (padlock). A beep sounds and the «bloc» symbol flashes in the display.

3 USE

After a predefined time, the lock will automatically disengage. Two beeps sound and «bloc» switches off. You can stop the Clean Lock at any moment by pressing and holding touchkey **b**.

3.10 ICS FUNCTION

Intelligent Cooking System

This function optimises the choice of cooking zone for the diameter of cookware used.

Proceed as follows:

Place the pan on the cooking zone, e.g. 28 cm dia.).

Select Boost power and possibly a cooking time.

Appuyez sur la touche **i**. Le symbole «ICS» apparait dans l'afficheur

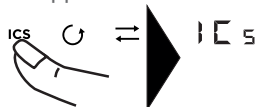

- either the zone chosen is the best one for the pan and «ICS» disappears leaving the initial cooking parameters in the display.

- or the zone chosen is not the best one for the pan and the display then indicates which zone should be used and the settings are transferred to it automatically.



N.B.: The hob must be cold to use this function..

3.11 RECALL FUNCTION

This function lets you display the last «power and timer» settings for all the burners which were switched off less than 3 minutes previously.

To use this function, the hob must be unlocked. Press the On/Off key and then give a short press on key **k**.



When the hob is operating, the function lets you see the power and timer settings for the burner(s) which have been switched off for less than 30 seconds.

3.12 SWITCH FUNCTION

This function allows a pan to be moved from one zone to another while retaining the original settings (power and time).

Give a short press on the **l** key;



==== symbols scroll through the display. Select the zone to which you wish to move the pan. The settings will be transferred to the selected zone and you can now move the pan.

3.13 BOIL FUNCTION

With this function you can boil and simmer water to cook pasta, for example.

Select a zone and give a short press on the «Boil» key **m**.



The default quantity of water displayed is 2 litres, but you can change it using the + or -

g



Set the quantity of water required (from 0.5 to 6 litres).

Confirm by pressing the «Boil» symbol or wait a few seconds for automatic confirmation.

Cooking starts.

A beep sounds when the water is boiling and the «Boil» symbol scrolls through the display.

3 USE

You can then add the pasta and confirm by pressing the «Boil» key.

By default, the display shows the power and a cooking time of 8 minutes.

You can still adjust the power and the cooking time suggested.

A beep sounds out when cooking is finished.

NOTE: It is important that water is at ambient temperature at the start of cooking or the final result will be distorted.

Do not use a cast iron pan with this function.

You can also use this function to cook any food that needs to be cooked in boiling water.



Advice on how to save energy

Cooking with the correctly sized lid saves energy. If you use a glass lid, you can control your cooking perfectly.

3.14 HORIZONE PLAY

— Horizone^{Play} — modèles



Your appliance is equipped with a guide at the rear of the cooking surface which allows De Dietrich accessories in the Horizone Play range, such as the chopping block, griddle or grill to be positioned.

Positioning accessories :

Position the groove (A) on your accessory on the guide (B) on your appliance.

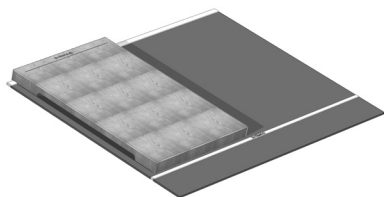

Do not slip Horizone Play accessories on to the cooking surface or you could scratch it.

3.15 GRILL FUNCTION/ PLANCHA

This function allows you to use grill or griddle type accessories in the «Horizone» free zone, so that food can be grilled.

The «Horizone» **d** must be selected; then give a short press on the Grill key **n** and «GRILL» appears in the upper display area.

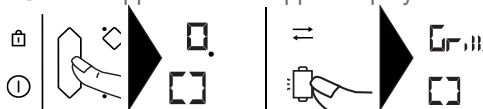

When the temperature required for the grill is reached, a beep sounds for 10 seconds and «GRILL» scrolls through the display.

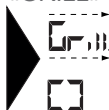

The timer cannot be used with the Grill and Griddle functions.

The Elapsed time function can only be used in consultation mode.

Pressing keys **f**, **g**, **o** exits the function.

In there is no pan in place, «Grill» flashes (like a power setting but you remain within the function).

3.16 SAFETY PRECAUTIONS AND RECOMMENDATIONS

Residual heat

After intensive use, the cooking area you have just used will remain hot for several minutes.

An «H» is displayed during this time.

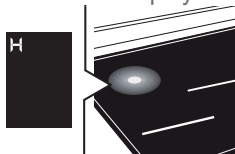

So, avoid touching the zones concerned.

3 USE

Temperature limiter

Each cooking area is fitted with a safety sensor that continuously monitors the temperature of the bottom of the pan. In the event that an empty pan is left on a zone that is switched on, the sensor automatically adapts the power delivered by the hob and limits the risk of damaging the cookware or the hob.

Spillage protection

The hob may be switched off in the following three cases:

- A spillage in the touchkey area.

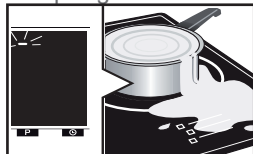

- Damp cloth placed over the touchkeys.
- A metal object placed on the touchkeys.



Remove the object or clean and dry the touchkeys and then continue cooking.

In these cases, the **—** symbol is displayed accompanied by an audible signal.

«Auto-Stop» system

If you forget to switch off a pan, your hotplate has an “Auto-Stop” safety function that automatically switches off the forgotten cooking zone after a preset time (between 1 and 10 hours based on the power level setting).

If the safety system is triggered, the cooking zone is shown as cut off with «AS» displayed on the control panel and a beep sounds for about 2 minutes. To stop it, simply press any of the control buttons.

 Sounds similar to the ticking of a clock may be heard.

These sounds occur when the hob is in operation and disappear or decrease according to the heating configuration. Low whistling or humming may also occur depending on the model and on the quality of your pan. These noises are a normal part of induction technology and do not indicate a fault.

 We do not recommend using any hob protection mechanisms.

4 CARE

For light soiling, use a kitchen sponge. Use hot water to wet the area to be cleaned and then wipe dry.

For burnt on food deposits, sugary spills, melted plastic, use a scouring sponge and/or a special glass cleaning scraper. Use hot water to wet the area to be cleaned, use a special glass cleaning scraper to remove the dirt, finish off with a scouring sponge and then wipe dry.

For rings and limescale marks, apply warm white vinegar to the dirt, leave to work and then wipe dry using a soft clean cloth.

To keep metal shining brightly and for weekly cleaning, use a special glass and ceramic hob cleaning product. Apply the special product (which contains silicone and has a naturally protective effect) to the vitroc ceramic hob.

Important note: Do not use power or abrasive sponges. Use cleaning creams and special gentle washing up sponges.

Care of the chopping block

Some precautions must be taken to maintain your product's quality and effectiveness. Before you use your chopping block for the first time, it should be oiled with cooking oil (one or two soup spoons rubbed over all surfaces with a clean cloth). This will maintain its appearance and ensure that it gives long service.

Care: Oil the block once a month. If the chopping board is only used for decoration, you are strongly advise to varnish it to prevent it from expanding or contracting.

NEVER wet the chopping board when cleaning it; scrape it with a knife blade or scraper to remove any excess dampness from cutting meat and keep the wood in perfect condition.

What you must never do to your chopping board:

- place it in contact with pans or very hot dishes.
- keep it too close to pulsed air heating or air conditioning, since these systems dry the air.
- over-exposure to sunlight in front of a window.
- excessive temperature differences.
- clamp it between two materials without allowing for expansion, if building it in.
- fitting it on a surface which is not yet dry during construction (plaster or cement which is still damp).

5 PROBLEMS

When using for the first time

You notice that something appears in the display. This is normal. It will disappear after 30 seconds.

The circuit breaker trips/blows a fuse or only one side of the hob works. The hob has been wired incorrectly. Check the wiring (see connections section).

The hob gives off a smell during the first few uses. The appliance is new. Heat each zone for half an hour with a pan full of water.

When switching on

The hob does not operate and the lights on the panel remain off.

There is no power to the hob. The power supply or connection is faulty. Inspect the fuses and the circuit-breaker.

The hob does not operate and another message is displayed. The electronic circuit does not operate properly. Call the After-Sales Service Department.

The hob does not work, the «bloc» information is displayed. Unlock the child safety lock.

Fault code F9: voltage is below 170 V.

Fault code F0: temperature is below 5°C.

During use:

The hob does not operate. The panel displays — and a beep can be heard.

There was a spillage or an object obstructing the control panel. Clean or remove the object and continue cooking.

Code F7 is displayed.

The electronic circuits have overheated (see 'building in' section).

During the operation of a **cooking area, the illuminated symbols of the control panel are still flashing.**

The pan being used is not suitable.

The cookware makes a noise and your hob clicks during cooking (see section on «Safety devices and recommendations»).

This is normal. With certain types of pan, heat passing from the hob to the pan causes this clicking.

The ventilation continues to operate after the hob is switched off.

This is normal. It helps cool the electronics.

In the event of a persistent malfunction.

Switch off the hob for one minute. If the problem persists, contact the After-Sales Department.

6 CUSTOMER SERVICE

Any repairs to your appliance must be made by a qualified professional accredited to work on the brand. When you call, in order to facilitate processing your request, make sure to have the following information relating to your appliance in front of you (commercial reference, service reference, serial number).

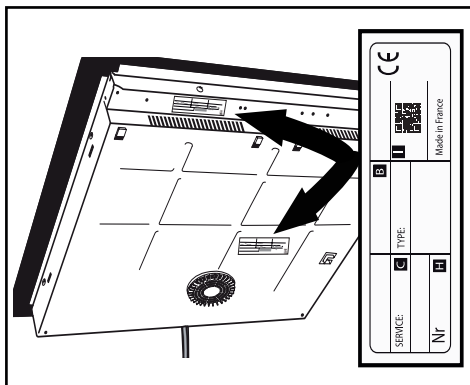

- B: Sales code
- C: Service number
- H: Serial number
- I: QR Code