

FR	GUIDE UTILISATION	KÄYTTÖOHJE	FI
EN	USER GUIDE	MANUALE D'USO	IT
CS	PRŮVODCE INSTALACÍ	HANDLEIDING	NL
DA	BRUGSANVISNING	BRUGSANVISNING	NO
DE	GEBRAUCHSANLEITUNG	GUIA DE UTILIZAÇÃO	PT
ES	GUÍA DE UTILIZACIÓN	BRUGSANVISNING	SV
ΕΛ	ΟΔΗΓΙΕΣ ΧΡ		

TABLE INDUCTION

INDUCTION HOB

INDUKČNÍ VARNÁ DESKA

INDUKTIONSPLADE

INDUKTIONSKOCHFELD

PLACA DE INDUCCIÓN

ΕΠΑΓΩΓΙΚΕΣ ΕΣΤΙΕΣ

INDUKTIOTASO

PIANO A INDUZIONE

INDUCTIEKOOKPLAAT

INDUKSJONSTOPP

PLACA DE INDUÇÃO

PLATŇA INDUKTIONSHÄLL

De Dietrich 

EN USER GUIDE

INDUCTION HOB

De Dietrich 

EN

DEAR CUSTOMER,

Discovering a De Dietrich product means experiencing a range of unique emotions.

The attraction is immediate, from the moment you set eyes on the product. The sheer quality of the design shines through, thanks to the timeless style and outstanding finishes which make each component an elegant and refined masterpiece in its own right, each one in perfect harmony with the others. Next, comes the irresistible urge to touch it.

De Dietrich design makes extensive use of robust and prestigious materials, where the accent is placed firmly upon authenticity. By combining state-of-the-art technology with top quality materials, De Dietrich produces beautifully crafted products to help you get the most from the culinary arts, a passion shared by all lovers of cooking and fine food. We hope that you enjoy using this new appliance.

Thank you for choosing a De Dietrich product.

www.dedietrich-electromenager.com



De Dietrich 

CONTENTS

Important safety advice and precautions.....	3
Presentation.....	7
Installation.....	8
Unpacking	8
Fitting.....	8
Connection	10
Use.....	11
Control panel glossary.....	11
Choice of cookware	12
Cooking zone selection	12
Powering On / Off.....	12
Power setting.....	12
Horizone	13
Setting the timer	13
Locking the controls.....	13
Clean lock function	14
Recall function.....	14
Perfect Sensor function	15
Cooking instructions	19
Safety and recommendations.....	21
Care	22
Problems	23
Environment.....	24
Customer service	25
Perfect Sensor Collection.....	26



IMPORTANT SAFETY ADVICE AND PRECAUTIONS

This user guide is also available on the brand's web site.

Please read these instructions before installing and using your appliance. They have been written for your safety and the safety of others. Keep this user guide with your appliance. If the appliance is ever sold or given to another person, ensure that the new owner receives the accompanying guide.

- With a view to constantly improving our products, we reserve the right to make changes to their technical, functional or aesthetic characteristics in line with technological progress.
- To easily locate the make, model number, etc. of your appliance, we recommend that you note this information on the "After-Sales Service Department and Customer Support" page.

This appliance may be used by children aged 8 years and older, and by persons with impaired physical, sensory or mental capacities, or without experience or knowledge, if they are supervised or have received prior instructions on how to use the appliance safely and have understood the risks involved.

Children must not be allowed to play with the appliance.

Cleaning and maintenance operations must not be carried out by children without supervision.

Children under 8 years of age should not be allowed near the appliance, unless they are constantly supervised.

The appliance and its accessible parts become hot during use.

Precautions must be taken to avoid touching the heating elements.

Metal objects such as knives, forks, spoons and lids must not be placed on the cooking surface as they may become hot.

Your hob is equipped with a child safety device that locks its operation after use or during cooking (See "Child Safety use" section).

Your appliance complies with applicable European Directives and regulations.

In order to avoid interference between your cooking hob and a heart pacemaker,



IMPORTANT SAFETY ADVICE AND PRECAUTIONS

the pacemaker must be designed and programmed in compliance with the regulations that apply to it. Ask the pacemaker manufacturer or your GP.

Leaving oil or fat to cook unattended on a hob can be dangerous and lead to fire. NEVER attempt to extinguish a fire with water. Instead, switch off the appliance and cover the flame with a lid or a fire blanket.

CAUTION: cooking must be monitored. Short cooking requires constant surveillance.

Danger of fire: do not store objects in the cooking zones. If the surface is cracked, turn off the appliance to avoid the risk of electric shock.

Do not use your hob until you have replaced the glass top.

Avoid impact with cookware: the vitroceramic

glass worktop is very sturdy; however, it is not unbreakable.

Do not place any hot lids flat on your cooking hob. A suction effect may damage the vitroceramic surface. Avoid dragging cookware across the surface, which could damage the decorative finish on the vitroceramic top in the long term.

Never use aluminium foil for cooking. Never place items wrapped in aluminium foil or packaged in aluminium dishes on your cooking hob. The aluminium will melt and permanently damage your appliance.

Do not store cleaning products or inflammable products in the cabinet underneath the hob.

These hobs must be connected to the mains via an all-pole cut-off device that complies with current



IMPORTANT SAFETY ADVICE AND PRECAUTIONS

installation regulations. A disconnection device must be incorporated into the fixed wiring.

Your cooktop is designed to operate at 50Hz or 60Hz (50Hz/60Hz) without any special intervention on your part.

If the power cable is damaged, it should be replaced by the manufacturer, its after-sales service department or a similarly qualified person, so as to avoid danger.

Ensure that the power cables of any electrical appliances plugged in close to the hob are not in contact with the cooking zones.

Never use a steam cleaner to clean your cooking hob.

The appliance is not designed to be switched on using an external timer or separate remote control system.

After use, turn off the hob using its control device

and do not rely on the pan sensor to do this.

WARNING: Only use hob protectors designed by the manufacturer of the cooking appliance or listed as suitable in the user guide, or included with the appliance. The use of unsuitable protectors could cause accidents.

Sensor

The probe is equipped with a CR2032 battery (use only the specified battery).

To unscrew the cover, use a coin to turn until the line aligns with the open lock.

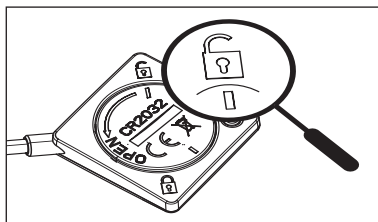

fig1.

To replace the cover, insert it, aligning the line with the open lock (fig 1.), then turn



IMPORTANT SAFETY ADVICE AND PRECAUTIONS

it with a coin to align the second line with the closed lock (fig 2.)

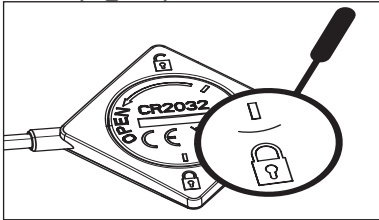

fig 2

Replace the battery when it is worn out or if it leaks.

The battery must be removed from the appliance before disposing of the appliance.

The battery must be disposed of in battery containers or taken back to your shop (in compliance with regulations in force).

- different types of batteries or new and used batteries must not be mixed;
- if the appliance has to be stored without being used for a long period, remove the batteries;
- the supply terminals must not be short-circuited.

- Non-rechargeable batteries must be not recharged.
- The sensor is not designed to go in an oven.

We, Brandt France, declare that the appliance equipped with the Perfect Sensor complies to directive 2014/53/EU. The full EU declaration of compliance is available on the following website: www.dedietrich-electromenager.com.

• 0 PRESENTATION



Thanks to the De Dietrich Perfect Sensor hob with its connected temperature sensor, you can perform every culinary gesture expertly and accurately, cook all meats and fish according to your tastes and succeed in your preparations, by adjusting the core temperature of your preparations.

Respecting the cooking temperature of the ingredients to the nearest degree allows for perfect cooking and culinary excellence.

The following functions are available with temperature feedback:

Thermometer / Melt / Warm / Vacuum cook / Slow cook / Boil

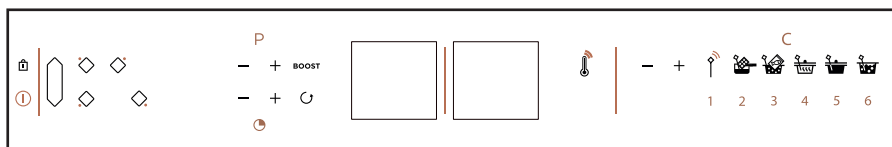

This hob is supplied with a connected temperature sensor and specific stand that can be easily positioned on any type of cookware. This sensor can be used on all cooking zones.

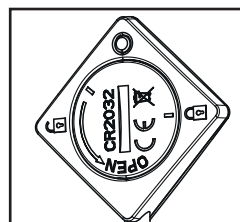
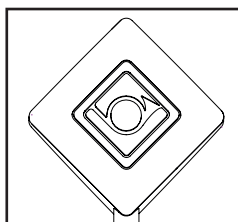
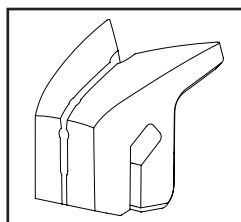

• 1 INSTALLATION



1.1 UNPACKING

Remove all the protective elements from the hob, the sensor and the sensor stand.

Your sensor is delivered with a battery that you must install. To insert the battery, unscrew the cover on the back of the probe with a coin until the line is aligned with the open latch, insert the battery respecting the polarity (+ on top) then screw the cover back on aligning the line with the open latch, then turn with a coin to align the second line with the closed cover.

Check and respect the characteristics of the appliance on the manufacturer's nameplate (1.1.1).

Note the service and standard references shown on this plate in the boxes below for future reference.

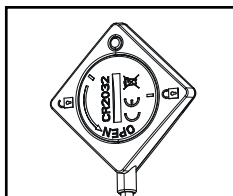

1.0

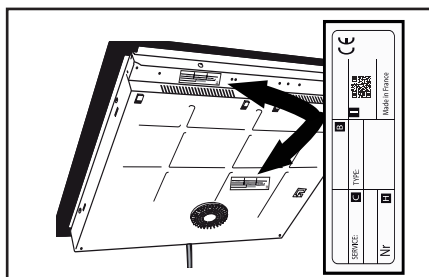

1.1.1

Service:

Type:

1.2 BUILDING INTO A BASE UNIT

Check that the air intakes and outlets are free of obstruction (1.2.1). Comply with the information concerning the fitting dimensions (in millimetres) of the base unit destined to receive the hob.

- Fitting into the worktop

See diagram (1.2.2)

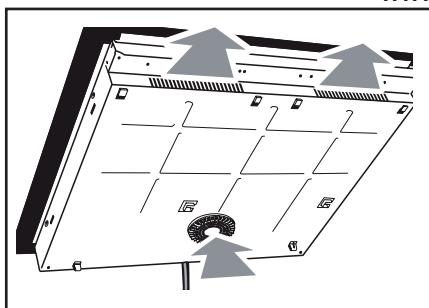

1.2.1

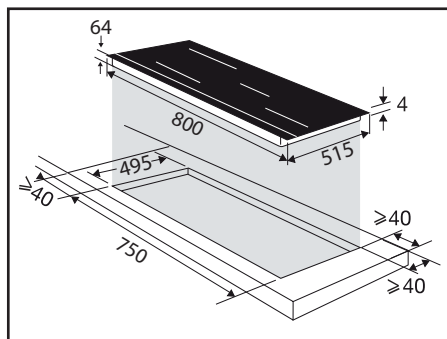

1.2.2

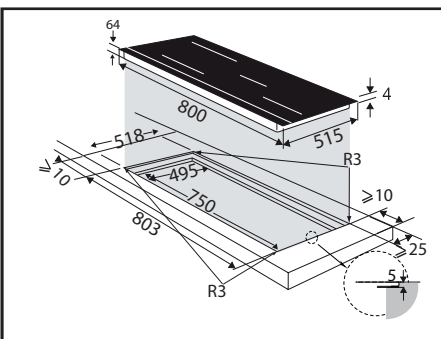

1.2.3

• 1 INSTALLATION



- Fitting flush with the worktop See diagram (1.2.3)

Check that air can flow correctly between the front and back of your hob.

If you are installing the hob above a drawer (1.2.6) or above a built-in oven (1.2.7), comply with the dimensions provided on the illustrations to ensure a sufficient air outlet at the front. Apply the seal all around the edge of the hob (1.2.8).

Fit the hob into the base unit (1.2.9).

 If your hob is located above your oven, the hob's thermal safety devices can impede the simultaneous use of the hob and the oven's pyrolysis programme. Your hob is equipped with an overheating prevention safety system. This safety device can trigger, for example, when the hob is installed over an oven that is not sufficiently insulated. The code "F7" then appears in the control zone. In such circumstances we recommend that you increase the hob's ventilation by creating an opening in the side of the cabinet (8cm x 5cm).

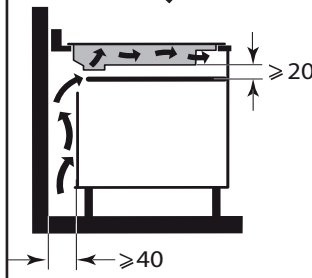
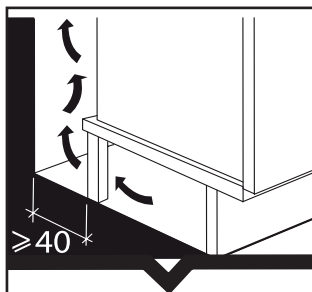

1.2.6

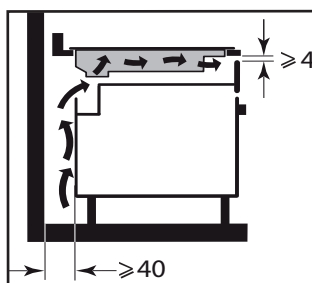

1.2.7

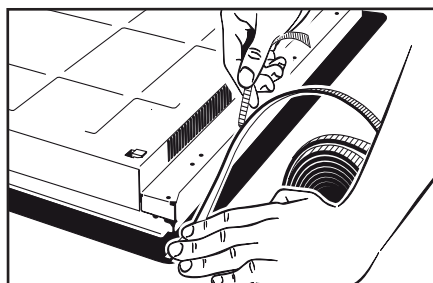

1.2.8

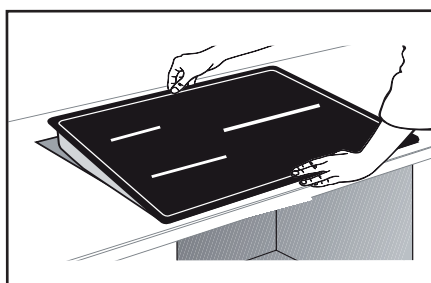

1.2.9

• 1 INSTALLATION



1.3 ELECTRICAL CONNECTIONS

This hob must be connected to the mains via an all-pole cut-off device that complies with current installation regulations. A disconnection device must be incorporated into the fixed wiring.

Identify the type of cable of your hob according to the number of wires and colours:

- 5-wire cable (**1.3.1**):

a) green/yellow, b) blue, c) brown, d) black, e) grey.

When power is first supplied to your hob, or after an extended power cut, a light code will appear on the control panel. Wait approximately 30 seconds or press any key on the control panel to make the information disappear and use your hob (this display is normal and is reserved for use by After-Sales Service, where applicable). In all cases, it should be disregarded.

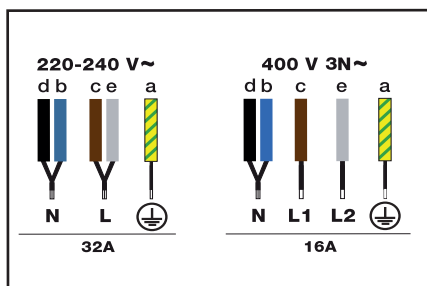

1.3.1

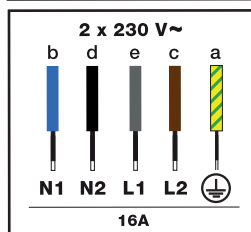

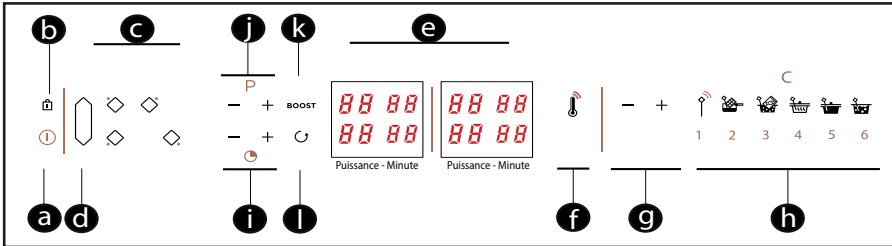

Control panel glossary

- a** = Switch on and off
- b** = Locking / Clean Lock (locks the hob during cleaning)
- c** = Choice of cooking zone
- d** = Horizone
- e** = Display (Power / minutes)
- f** = Thermometer function (temperature display)
- g** = Sensor adjustment
- h** = Cooking functions
 - Expert **[1]** / Melt **[2]** /
 - Vacuum cook **[3]** / Warm **[4]** / Slow cook **[5]** / Boil **[6]**
- i** = Timer setting
- j** = Power setting
- k** = Boost (maximum power)
- l** = Recall function (Reminder of power & timer settings)

• 2 USE

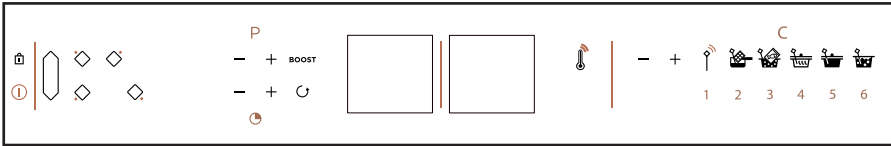

2.1 CHOICE OF COOKWARE

Most cookware is compatible with induction. Only glass, terracotta, aluminium without a special base, copper and some non-magnetic stainless steels do not work with induction cooking.



We suggest that you choose cookware with a thick, flat bottom. The heat will be distributed better and cooking will be more uniform. Never leave an empty pan to heat unattended.



Avoid putting cookware on the control panel.

2.2 COOKING ZONE SELECTION

There are several cooking zones available. Select one which is suitable, based on the size of the pan. If the base of the cookware is too small, the power indicator will start to flash and the cooking zone will not work, even if the cookware's material is recommended for induction. Take care not to use pans which are smaller in diameter than the cooking zone (see table)

Diameter of cooking zone	Maximum power of cooking zone (Watts)	Diameter of bottom of cookware
16 cm	2400	10 to 18 cm
28 cm	3700	15 to 32 cm
Horizone	3700	18 cm, oval, fish pan

When several cooking zones are used at the same time, the hob manages the power distribution, so as not to exceed its total power.

2.3 SWITCHING ON/OFF

Press the On/Off touchkey . A "0" flashes in each zone for 8 seconds.



If no pan is detected, select a zone . If a pan is detected, the "0" flashes with a dot.

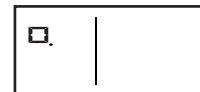

You can then adjust the power. If you do not select a power level, the cooking zone will automatically turn itself off.

Switching off a zone on the hob

Press and hold the key for the zone , a long beep sounds and the display goes off or an "H" appears (residual heat).

Press the On/Off key to switch the hob off completely.

2.4 SETTING THE POWER

Press the key $-^P+$ When switching on, you can go directly to maximum power (apart from boost) by pressing the "-" key.

• 2 USE

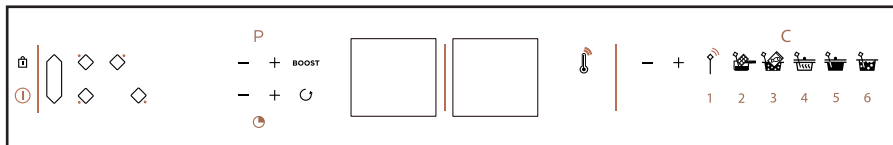

2.5 HORIZONE — **Horizone^{tech}** —

The free zone is selected with touchkey . The power and timer are adjusted as for a normal cooking zone.

To switch the zone off, press and hold the key ; a long beep sounds and the displays go off or the "H" symbol appears. Pressing the touchkey in front of or behind the zone deactivates the function and transfers the settings to the selected zone.

2.6 SETTING THE TIMER

Each cooking zone has a dedicated timer. This can be set once the relevant cooking area is in operation.

To turn it on or change the timing, press the timer button . To make it easier to set a very long time, you can directly reach 8 hours by pressing the touchkey ; each additional press changes the timer to 7h, 6h, 5h, 4h, 3h, 2h, 99 min, etc.

At the end of cooking, the display indicates 0 and a warning beep sounds. To cancel this information, press any button for the particular cooking zone being used. Otherwise, they will switch off after a few seconds.

To stop the timer during cooking, press the + and - keys or return to 0 using the - key.

Independent timer

With this function, you can time an event without cooking.

- Select a zone that is not in use
- Press ; a "t" with a dot is shown

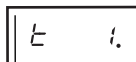

- Set the time with - or +.

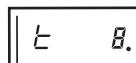

- the display of the remaining time is fixed.
- You can stop a countdown that has started by holding the cooking zone selection key.
- At the end of the countdown, a double beep sounds for 20 seconds.

2.7 LOCKING THE CONTROLS

Child safety

Your hob has a child safety device which locks the controls when the hob is not in use or during cooking (to maintain the current settings). For safety reasons, only the stop key and the zone selection keys are still active and allow the hob or a cooking zone to be switched off.

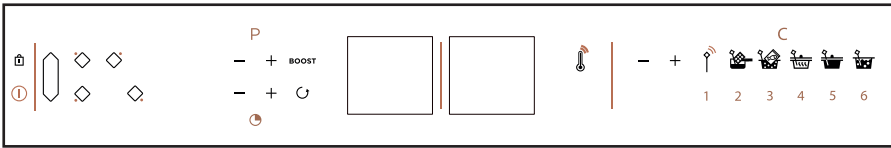

Locking

Press and hold the key  until the "bloc" locking symbol appears in the displays and a short beep confirms the operation.

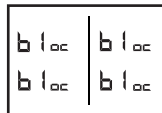



Table locked in operation



The display of cooking zones in operation alternately indicates power and the locking symbol .
When you press the power or timer keys for the zones which are "on": "bloc" appears for 2 seconds and then switches off.

Unlocking

Press the key  until the "bloc" locking symbol disappears from the display and a beep confirms the operation.

CLEAN LOCK function

This function locks the hob off while it is being cleaned.
To activate Clean lock:



Give a short press on the key  (padlock). A beep sounds and the "bloc" symbol flashes in the display.
After a predefined time, the lock will automatically disengage. Two beeps sound and "bloc" switches off. You can stop the Clean Lock at any moment by pressing and holding the key .

2.8 RECALL FUNCTION

This function lets you display the last "power and timer" settings for all the burners which were switched off less than 3 minutes previously.

To use this function, the hob must be unlocked. Press the On/Off key and then give a short press on the key .

When the hob is in operation (at least one burner on), give a short press on the key . This function reminds you of the power and timer settings for the burner(s) which have been switched off for less than 30 seconds.

When the hob is switched off (all burners off), press the On / Off button , then give a short press on the button . The function reminds you of the power and timer settings for the burner(s) which have been switched off for less than 3 minutes.



Advice on how to save energy

Cooking with the correctly sized lid saves energy. If you use a glass lid, you can control your cooking perfectly.

2.9 PERFECT SENSOR FUNCTION



There are three ways of using the function
- **View** the temperature measured in the

• 2 USE

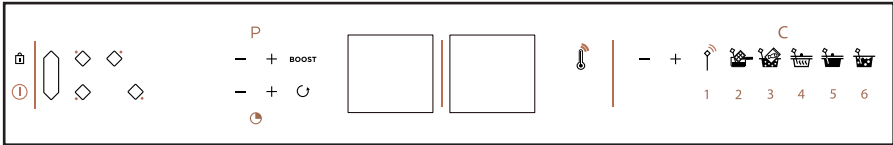

dish directly on the hob's display.

- **Programme** a temperature setpoint to be reached in the dish (Expert)
- **Set** the temperature thanks to the 5 cooking functions proposed.

Pairing the sensor with the hob

Pairing takes place only once when using the sensor for the first time or when replacing it.

The hob must be off.

1 - Press the on / off button on the back of the sensor for 3 seconds; the sensor gives off a blue flash and then flashes green



2 - Hold down  ; **Conn Ect.** is displayed and the sensor flashes green.

3 - Give a short press on  ; the hob gives

a confirmation beep; **Conn Ect.** flashes to confirm the pairing. The sensor flashes blue (this step may take up to 15 seconds).

 **the sensor is not designed to go in an oven.**

Positioning of the sensor

There are 3 recommended positions:

- Vertical

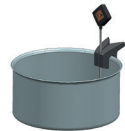

- Intermediate (adjustable)



- Slanted



It is not recommended to use the sensor in its stand.

Using the sensor

To operate the sensor, you need to switch it on (press the button for several seconds); switch on the hob and then select a burner. When setting the temperature, the hob automatically adjusts the necessary power which may cause a difference in boiling.

• 2 USE

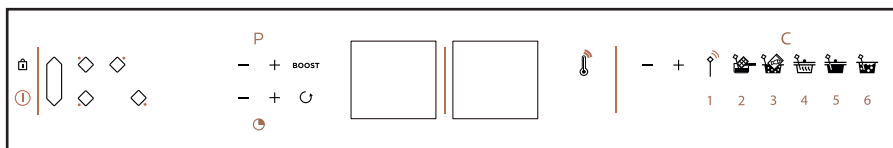

This function allows you to melt food at a temperature that can be adjusted between 40 and 70°C. The setpoint temperature is 50°C. During this type of cooking, the sensor must be vertical and the tip of the sensor must touch the base of the pan.

Mix well during cooking to homogenise the mix.

During this type of cooking, the sensor must touch the base of the pan.

This function is available only on the 16 cm, 23 cm or 1/2 Horizonte burners on your hob.



When setting the temperature, there may be a variation in boiling.



This function allows you to boil water at a temperature of 100°C.

You can partially cover your cookware with a lid; we recommend you do this from the start of cooking.



This function is not intended to boil milk. In this case, use the slow cooking function.



This function allows you to cook food at a temperature that can be adjusted between 45 and 85°C. The setpoint temperature is 60°C.



This function allows you to warm food at a temperature that can be adjusted between 65 and 80°C. The setpoint temperature is 70°C.



This function allows you to simmer food at a temperature that can be adjusted between 80 and 90°C. The setpoint temperature is 80°C.

• 2 USE



Warning:

- You can programme a time in sensor mode. In this case, the time is displayed alternately with the temperature.
- The sensor can only be used on one burner at a time.
- At the end, do not forget to switch off the sensor with a long press on the sensor; the LED lights up in red for a few seconds.
- The sensor turns off automatically 1 minute after the hob is turned off.
- To avoid damaging your sensor, do not put the electronic box of the sensor directly above the cooking fumes.
- The boiling temperature of water may vary depending on the altitude and atmospheric conditions of your geographical situation.
- A loss of communication may be caused by a weak battery.

Technical information regarding the sensor:

Parameter	Specifications	Notes
Voltage	2.5 - 3V	CR2032 battery
Autonomy	300 hours	with new battery
LED colour	White Green Blue Red	On Awaiting connection Connected Off
Operating temperature	0 - 85°C	Sensor's box
Temperature measurement range	5° - 180°C	
Working frequency	2402 - 2480 MHz	
Reach of the sensor	2 metres	
Maximum power	< 10 mW	



Cooking instructions:

Function	Basic ingredient or dish	Quantity (g)	Temperature (°C)	Time	Tips
Expert	White meat	150g chicken filets	80°C	8 to 12 min	Flatten the breasts (1/1.5 cm high)
	Red meat	150 to 200g	35 to 45°C (blue)	30s to 2 min/side (depending on thickness)	Leave the meat to rest for 5 min after cooking
		150 to 200g	50 to 55°C (rare)	1 min to 3 min/side (depending on thickness)	Leave the meat to rest for 5 min after cooking
		150 to 200g	60 to 65°C (medium)	1 min 30 to 4 min (depending on thickness)	Leave the meat to rest for 5 min after cooking
		150 to 200g	70 to 75°C (well done)	2 min to 8 min/side (depending on thickness)	Leave the meat to rest for 5 min after cooking
	Frozen fries	200g / 1.5l oil	160° then 180°C	11 min 2 min 30s	Plunge for 11 minutes then remove, plunge again for 2 min 30s as soon as the temperature reaches 180°C to finish cooking
	Béchamel sauces	500	85 to 87°C	Boil for 1 minute	Stir constantly during cooking to avoid sticking to the bottom of the pan
	Chocolate creams	1300	87 to 92°C	8 to 10 min	Stir constantly during cooking to avoid sticking to the bottom of the pan
	Caramel	"dry" (100g)	up to 150°C (colouration)	3 to 5 min (power level 10)	Browning happens very quickly, stay alert.
	Caramel	with water (100g sugar/60 ml water)	up to 145°C	8 to 12 min (power level 10)	Monitor the boiling. When it stops, browning occurs very quickly.
Fruit jellies	400 - 1000	105 - 110	depending on quantity	EXPERT (use 1 to 1.2% pectin / kg of fruits)	
Melt	Dark chocolate	100 - 500	50 - 55	5 to 10 min	Stir frequently
	Milk chocolate		45 - 50		
	White chocolate		45 - 50		
	Butter	50 - 500	40 - 50	5 to 20 min	
	Clarified butter	50 - 500	40 - 50	5 to 20 min	do not stir to properly decant the casein from the butter
	Fondue cheese	200 - 1500	40 - 50	10 to 25 min	the quantity of wine added for cooking will affect the melting time (50cl for 1kg of cheese)
Warm	Purée	200 - 800	65 - 75	Depending on quantity	
	Soup	200 - 2000	65 - 75	2 min 30 to 15 min	attention, depending on the viscosity of the soup, the time may vary.
	Jars / preserves	300 - 1000	65 - 75	4 min to 10 min	test carried out on cassoulet preserves
	Small pots	125 - 300	60 - 70	Depending on quantity	Test the temperature before eating



Cooking instructions:

Function	Basic ingredient or dish	Quantity (g)	Temperature (°C)	Time	Tips
Slow cooking	Stew	1000 - 4000	70 - 80	2 hours 30 to 3 hours	Adjust the cooking container to the quantity to cook. Add the peeled potatoes before the last 1/2 hour of cooking
	Veal blanquette	1000 - 4000	70 - 80	2 to 3 hours	Adjust the cooking container to the quantity to cook.
	Bourguignon	1000 - 4000	70 - 80	2 to 4 hours	Adjust the cooking container to the quantity to cook.
	Casserole	1000 - 4000	70 - 80	2 to 4 hours	Adjust the cooking container to the quantity to cook.
	Basque-style chicken	1000 - 4000	70 - 80	1 hour 15 to 1 hour 30	Adjust the cooking container to the quantity to cook.
	Jam	1000 - 4000	105	20 min to 1 hour depending on the fruit, check the texture)	The gelling temperature of jam is 105°C (sugar thermometer). This temperature can be decreased to around 90°C by adding pectin (15g for 1kg of fruits)
	Tomato sauce	1000 - 4000	70 - 80	40 min	Be careful of the acidity of the tomatoes during cooking. Add a pinch of powdered sugar to fresh tomato sauce during cooking.
Vacuum cooking	Fish	250-300g salmon	45-50	20 min	Between 3L and 5L of water. Be careful when seasoning as vacuum cooking tends to intensify the power of salt.
	Fish	250-300g white fish	56°C	15 min	
	Vegetables	200-300g green vegetables	85°C	30-75 min	
	Vegetables	150g root vegetables	85°C	60 - 80min	
	White meat	150g chicken fillets	64°C	25 min	
	White meat	200g chicken thighs	68°C	120 min	
	Red meat	150 to 300g beef fillet	56,5°C water bath	30 min for 2,5 cm thickness / 2 hours for 5 cm thickness / up to 4 hours.	
Perfect eggs	50g / 1l water	64°	45 min	1L water	
Boil	Rice	100-500 (dry) = 300 to 1500 ml of salty water	90-100	12 to 20 minutes depending on the rice	"Creole" rice: bring the water to the boil. Pour on the rice(rinse with cold water first), cover and leave to cook on gentle heat (attention, some types of rice require more cooking time: "venerated" rice)
	Pasta	100 - 500 (dry) = 1L to 5L of salty water	90-100	10 to 12 min cooking	Bring the water to the boil. "Pour on the pasta and simmer. Check the cooking depending on the type of pasta used.



2.10 SAFETY PRECAUTIONS AND RECOMMENDATIONS

Residual heat

After intensive use, the cooking area you have just used will remain hot for several minutes.

A "H" symbol is displayed during this time. Avoid touching the areas concerned.



Temperature limiter

Each cooking zone is fitted with a safety sensor that continuously monitors the temperature of the bottom of the pan. In the event that an empty pan is left on a zone that is switched on, the sensor automatically adapts the power delivered by the hob and limits the risk of damaging the cookware or the hob.

Spillage protection

The hob may be switched off in the following three cases:

- Spillage covering the control keys.
- Damp cloth placed over the keys.
- Metal object placed on the control keys.

Remove the object or clean and dry the keys and resume cooking.

In these cases, the symbol  is displayed accompanied by an audible signal.



"Auto-Stop" system

If you forget to switch off a pan, your hob has an "Auto-Stop" safety function that automatically switches off the forgotten cooking zone after a pre-set time (between 1 and 10 hours based on the power level setting).

If the safety system is triggered, the cooking zone is shown as cut off with "AS" displayed on the control panel and a beep sounds for about 2 minutes. To stop it, simply press any of the control keys.



Sounds similar to the ticking of a clock may be heard.

These sounds occur when the hob is in operation and disappear or decrease according to the heating configuration. Low whistling or humming may also occur depending on the model and on the quality of your pan. These noises are a normal part of induction technology and do not indicate a fault.



We do not recommend using any hob protection mechanisms.

• 3 CARE



Looking after the hob

For light soiling, use a kitchen sponge. Use hot water to wet the area to be cleaned and then wipe dry.

For burnt-on food deposits, sugary spills, melted plastic, use a scouring sponge and/or a special glass cleaning scraper. Use hot water to wet the area to be cleaned, use a special glass cleaning scraper to remove the dirt, finish off with a scouring sponge and then wipe dry.

For rings and limescale marks, apply warm white vinegar to the dirt, leave to work and then wipe dry using a soft clean cloth.

For shiny metal streaks and weekly maintenance, use a special vitroceramic glass product. Apply the special product (which contains silicon and preferably has a protective effect) to the vitroceramic glass.

Important note: do not use abrasive powders or scourers. Use cleaning creams and special gentle washing up sponges.

Looking after the sensor

- Clean the sensor before using for the first time
- Only use neutral products, no abrasive products, scouring pads, solvents or metal objects.
- Do not wash the sensor in the dishwasher.
- The sensor's stand can be washed in the dishwasher.

• 4 PROBLEMS



When using for the first time

You notice that something appears in the display. This is normal. It will disappear after 30 seconds.

The circuit breaker trips/blows a fuse or only one side of the hob works. The hob has been wired incorrectly. Check the wiring (see connections section).

The hob gives off a smell during the first few uses. The appliance is new. Heat each zone for half an hour with a pan full of water.

When powering on

The hob does not operate and the lights on the panel remain off.

There is no power to the hob. The electrical supply or the connection are faulty. Inspect the fuses and the circuit-breaker.

The hob does not work and another message is displayed. The electronic circuit does not operate properly. Contact the After-Sales Department.

The hob does not work, the “bloc” information is displayed. Unlock the child safety lock.

Fault code F9: voltage less than 170 V.

Fault code F0: temperature less than 5°C.

During use:

The hob does not work. The – information is displayed and a beep sounds.

There was a spillage or an object obstructing the control panel. Clean or remove the object and continue cooking.

Code F7 is displayed.

The electronic circuits have overheated (see 'building in' section).

During the operation of a cooking area, the illuminated symbols of the control panel continue to flash.

The pan being used is not suitable.

The cookware makes a noise and your hob clicks during cooking (see “Safety precautions and recommendations”).

This is normal. With certain types of pan, heat passing from the hob to the pan causes this clicking.

The ventilation continues to operate after the hob is switched off.

This is normal. It helps cool the electronics.

In the event of a persistent malfunction.

Switch off your hob for 1 minute. If the problem persists, contact the After-Sales Department.

Sensor

A loss of communication of the sensor may be caused by a weak battery.

If  is displayed: the sensor is not paired or is switched off. If the problem persists, check the battery position.

If  is displayed: the sensor is already in use on another burner.

If  is displayed + a BEEP: The temperature measured is incompatible with the selected function. Check the suitability of the chosen area and the selected function.

• 4 PROBLEMS



The sensor flashes red:

- Before switching off if the battery is too weak.
- In the event of loss of communication, flashes red and then green depending on whether connection with the hob is restored or not.

• 5 ENVIRONMENT



ENVIRONMENTAL COMPLIANCE

The packaging material of this appliance is recyclable. Please recycle it and help protect the environment by depositing it in municipal containers provided for this purpose.



Your appliance also contains many recyclable materials. It is therefore marked with this logo to indicate that used appliances should not be mixed with other waste.

Recycling of appliances organised by your manufacturer is carried out under the best conditions, in accordance with the European regulation on waste disposal of electronic and electrical equipment.

Contact your local authority or retailer for information on used appliance collection points close to your home.

We thank you for your help in protecting the environment.

• 6 CUSTOMER SERVICE



SERVICING AND REPAIRS FRANCE

Any repairs to your appliance must be made by a qualified professional accredited to work on the brand. When calling, please provide the full references of your appliance (commercial reference, service reference, serial number), so that we can handle your call more efficiently. This information appears on the manufacturer's nameplate (1.1.1).

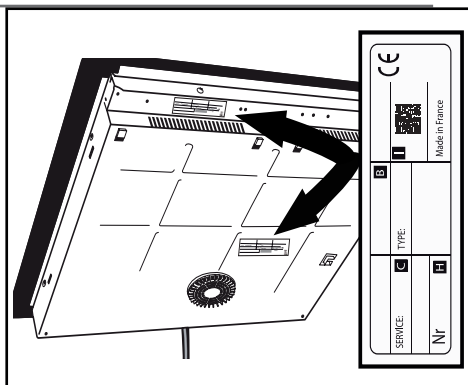

B: Sales code

C: Service number

H: Serial number

I: QR Code

